

NOTES:

1. PLATING THICKNESS TO BE PER CUSTOMER'S SPECIFICATION.
2. SEAL AREA TO BE METALLIZED.
3. DIE ATTACH AREA TO BE METALLIZED.
4. SEAL RING AND DIE ATTACH PAD TO BE FLOATING FROM ANY PINS.
5. EXTRA PIN (D4) TO BE FLOATING FROM ANY PINS.
6. LEAD RESISTANCE : 800 mΩ MAX.

						NAME 121 PIN GRID ARRAY PACKAGE		TOLERANCE UNLESS OTHERWISE SPECIFIED ± .005 THIRD ANGLE PROJECTION		DRAWN S.M		CHECKED S.A		APPROVED T.A		DATE NOV.26,'86	
MODIFICATION						SCALE 5/1		MATERIAL AS INDICATED		DRAWING NO. KD-P86A76-C		SHEET 1/8					
△ ADDED : SHEETS No.4/8~8/8						SEP.22.'98		S.Y SHK/S.NI T.A									
△ REDRAWN						DEC.9.'93		S.N H.S/K.M T.A									
△ REDRAWN						3.14.'19		N.I A.F/T.A M.K									
CHANGED						DATE		DRAWN		CHECKED		APPROVED					

PB121SA76-1 S=0 D=0



KYOCERA CORPORATION  
KYOTO JAPAN

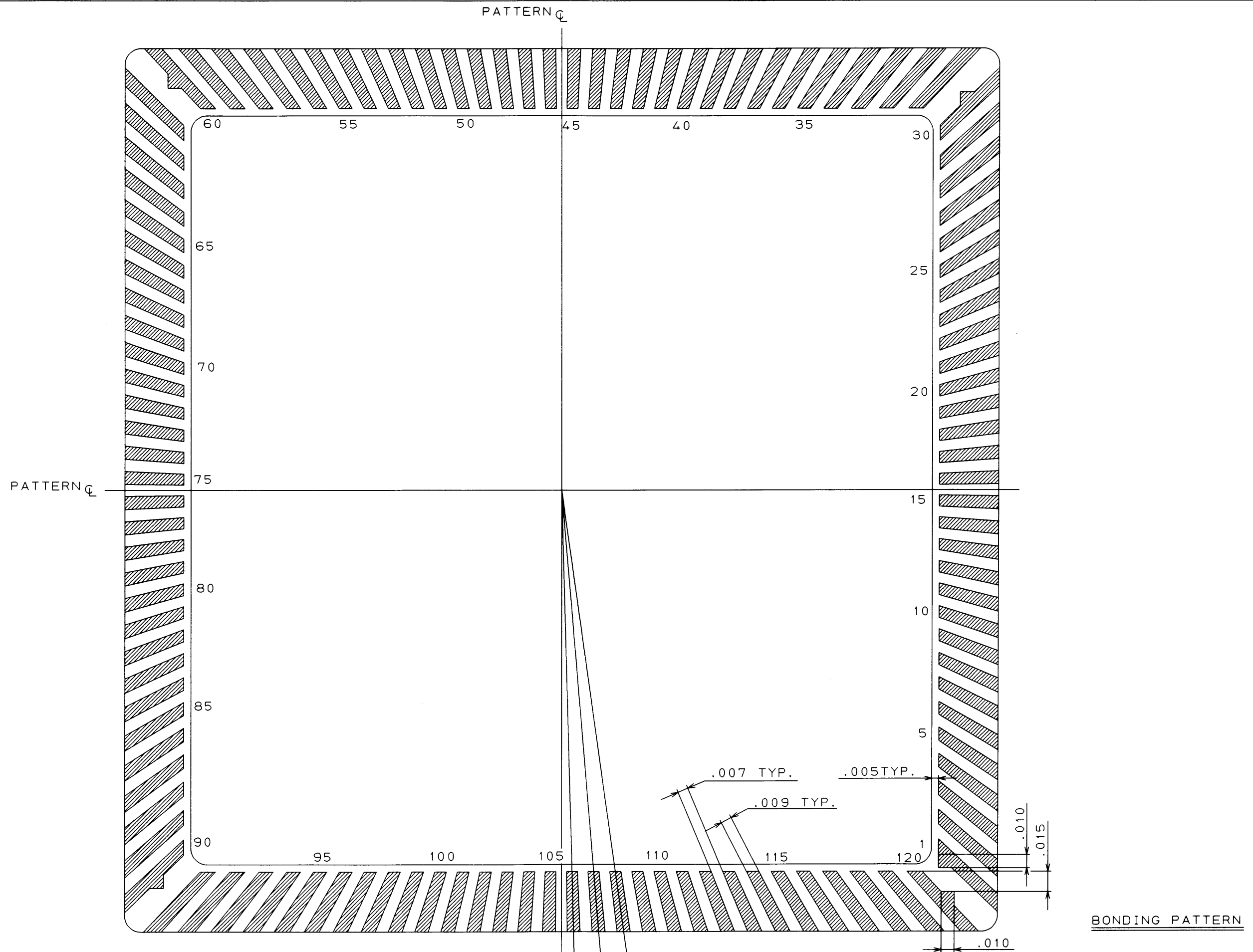

BONDING PATTERN

MODIFICATION						NAME	TOLERANCE	DRAWN	CHECKED	APPROVED	DATE
						121 PIN GRID ARRAY PACKAGE	UNLESS OTHERWISE SPECIFIED	S.M	S.A	T.A	NOV.26.'86
						SCALE 20/1	MATERIAL	THIRD ANGLE PROJECTION			
	REDRAWN	DEC.9.'93	S.N	H.S/K.M	T.A	KYOCERA	KYOCERA CORPORATION KYOTO JAPAN	DRAWING NO.			SHEET
	CHANGED							KD-P86A76-C			2/8

WIRE BOND PAD / CONNECTOR PIN INTERCONNECTION PLAN

W/B NO.	PIN NO.	W/B NO.	PIN NO.	W/B NO.	PIN NO.	W/B NO.	PIN NO.	W/B NO.	PIN NO.	W/B NO.	PIN NO.
1	C3	21	J1	41	N5	61	L11	81	E13	101	A9
2	B2	22	J2	42	L6	62	M12	82	E12	102	C8
3	B1	23	K1	43	M6	63	M13	83	D13	103	B8
4	D3	24	J3	44	N6	64	K11	84	E11	104	A8
5	C2	25	K2	45	M7	65	L12	85	D12	105	B7
6	C1	26	L1	46	L7	66	L13	86	C13	106	C7
7	D2	27	M1	47	N7	67	K12	87	B13	107	A7
8	E3	28	K3	48	N8	68	J11	88	D11	108	A6
9	D1	29	L2	49	M8	69	K13	89	C12	109	B6
10	E2	30	N1	50	L8	70	J12	90	A13	110	C6
11	E1	31	L3	51	N9	71	J13	91	C11	111	A5
12	F3	32	M2	52	M9	72	H11	92	B12	112	B5
13	F2	33	N2	53	N10	73	H12	93	A12	113	A4
14	F1	34	L4	54	L9	74	H13	94	C10	114	C5
15	G2	35	M3	55	M10	75	G12	95	B11	115	B4
16	G3	36	N3	56	N11	76	G11	96	A11	116	A3
17	G1	37	M4	57	N12	77	G13	97	B10	117	A2
18	H1	38	L5	58	L10	78	F13	98	C9	118	C4
19	H2	39	N4	59	M11	79	F12	99	A10	119	B3
20	H3	40	M5	60	N13	80	F11	100	B9	120	A1
S/R	NC	D/A	NC	EXTRA PIN (D4)	NC						

MODIFICATION						NAME	TOLERANCE	DRAWN	CHECKED	APPROVED	DATE
						121 PIN GRID ARRAY PACKAGE	UNLESS OTHERWISE SPECIFIED	S.M	S.A	T.A	NOV.26,'86
						SCALE $\times$	MATERIAL	$\pm$ —	<i>S. Yama</i>	<i>M. K.</i>	<i>T. Atsu</i>
	RE DRAWN		3.14.'91	N. I	A.F/T.A	M. K	THIRD ANGLE PROJECTION	DRAWING NO.			SHEET
	CHANGED		DATE	DRAWN	CHECKED	APPROVED	KYOCERA CORPORATION KYOTO JAPAN			KD-P86A76-C	3/8

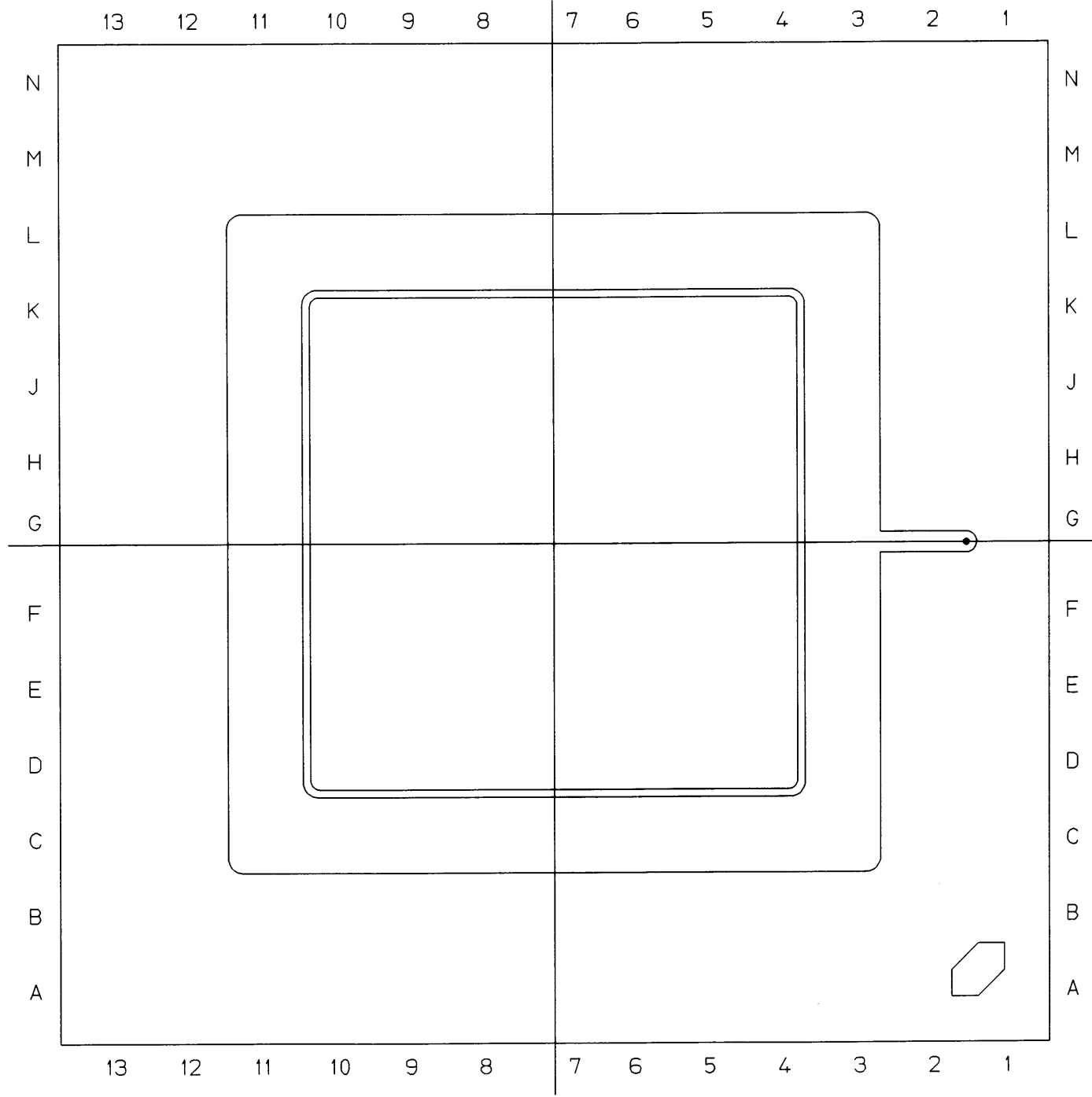

MP-1

MODIFICATION						NAME	TOLERANCE	DRAWN	CHECKED	APPROVED	DATE
						121 PIN GRID ARRAY PACKAGE	UNLESS OTHERWISE SPECIFIED	S. Y	SH.K/S.NI	A. T	SEP.22.'98
						SCALE 5 / 1	MATERIAL	<i>S. Yama</i>	<i>SH.K</i>	<i>T. Atsu</i>	
							THIRD ANGLE PROJECTION				
	△ ADDED : THIS SHEET	SEP.22.'98	S. Y	SH.K/S.NI	A. T		KYOCERA CORPORATION KYOTO JAPAN	DRAWING NO.		SHEET	
	CHANGED	DATE	DRAWN	CHECKED	APPROVED			KD-P86A76-C		4/8	

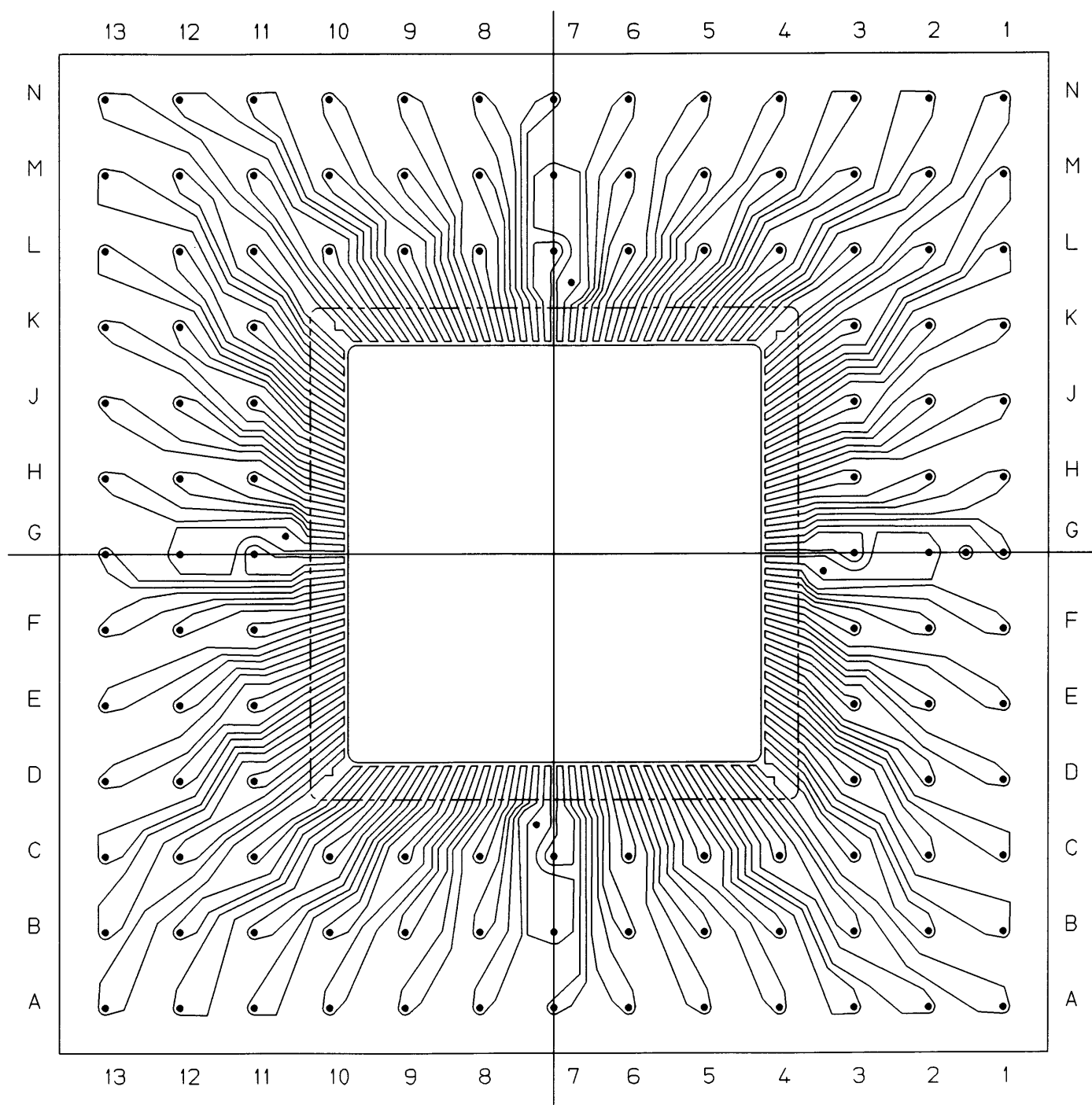

MP-2

MODIFICATION						NAME 121 PIN GRID ARRAY PACKAGE	TOLERANCE UNLESS OTHERWISE SPECIFIED	DRAWN S. Y	CHECKED SH.K/S.NI	APPROVED A. T	DATE SEP.22.'98
						SCALE 5 / 1	MATERIAL	<i>S. Yama</i>	<i>SH.K</i>	<i>A. T</i>	
	△	ADDED : THIS SHEET	SEP.22.'98	S. Y	SH.K/S.NI	A. T	 KYOCERA CORPORATION KYOTO JAPAN	THIRD ANGLE PROJECTION		DRAWING NO. KD-P86A76-C	SHEET 5/8
	CHANGED	DATE	DRAWN	CHECKED	APPROVED						

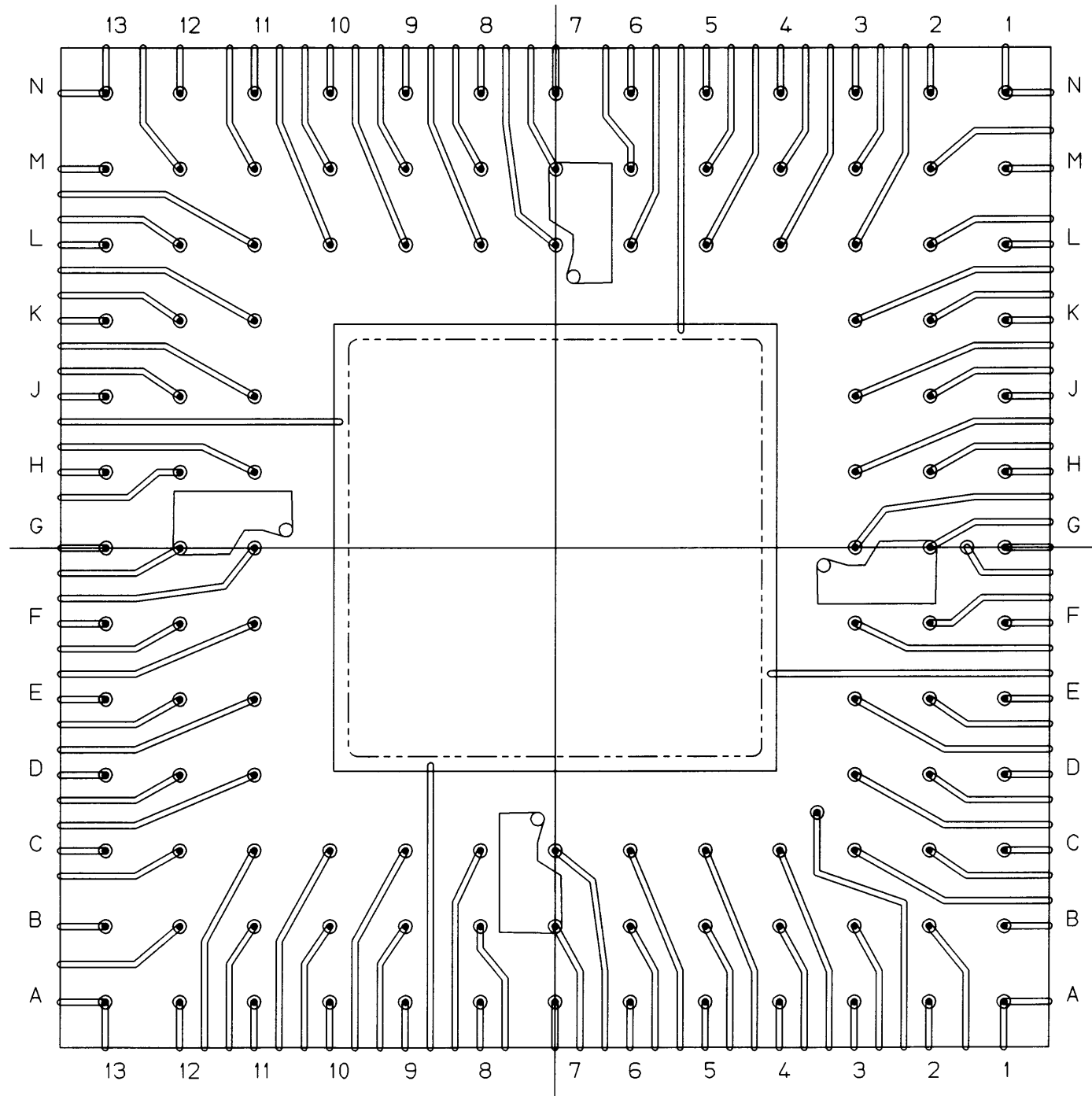

MP-3

MODIFICATION						NAME 121 PIN GRID ARRAY PACKAGE	TOLERANCE UNLESS OTHERWISE SPECIFIED	DRAWN S. Y	CHECKED SH.K/S.NI	APPROVED A. T	DATE SEP.22.'98
						SCALE 5 / 1	MATERIAL	<i>S. Yama</i>	<i>SH.K</i>	<i>T. Atsu</i>	
	△	ADDED : THIS SHEET CHANGED	SEP.22.'98	S. Y	SH.K/S.NI	A. T		KYOCERA CORPORATION KYOTO JAPAN	DRAWING NO. KD-P86A76-C		SHEET 6/8

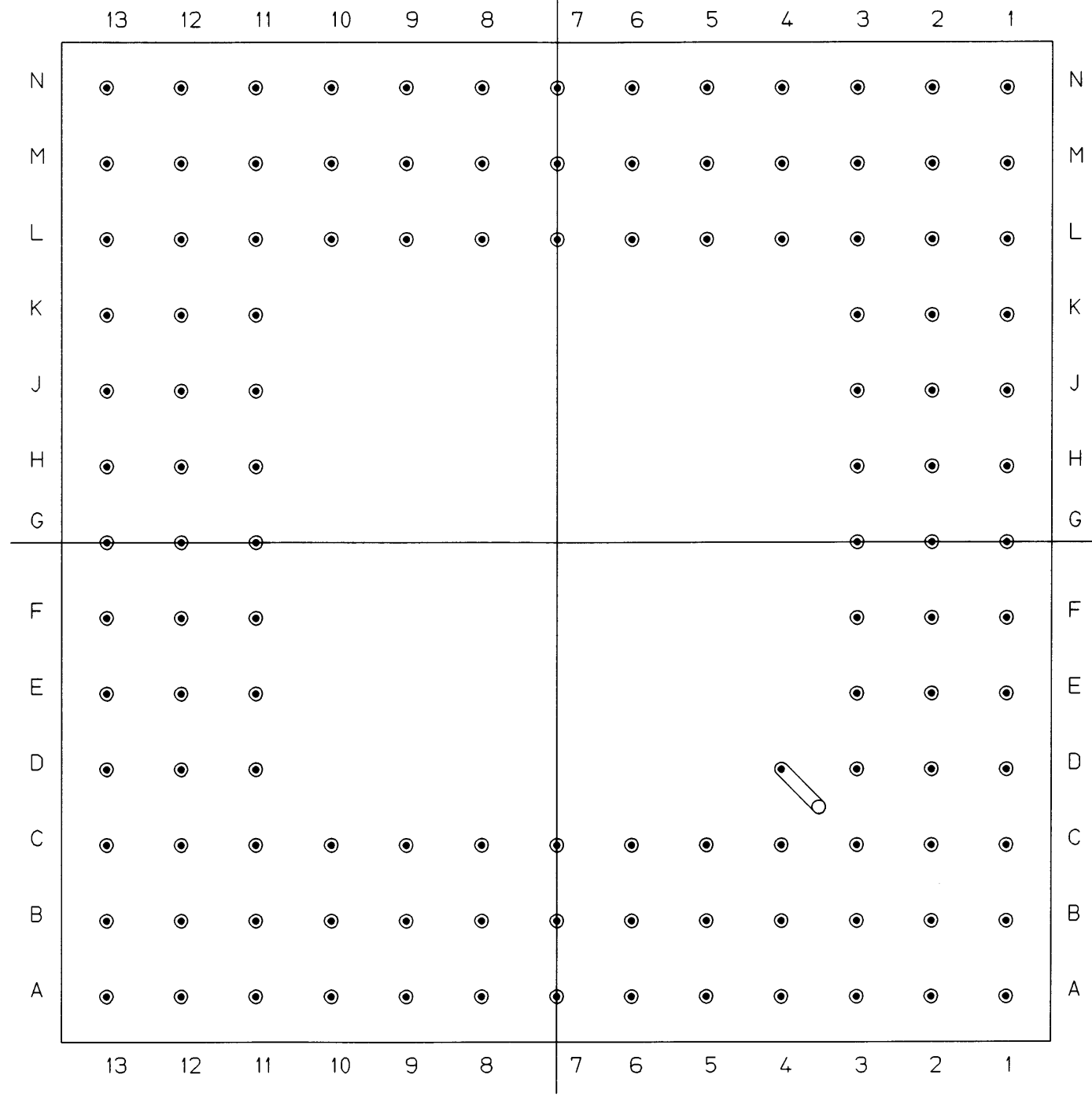

MP-4

MODIFICATION						NAME	TOLERANCE	DRAWN	CHECKED	APPROVED	DATE
						121 PIN GRID ARRAY PACKAGE	UNLESS OTHERWISE SPECIFIED	S. Y	SH.K/S.NI	A. T	SEP.22.'98
						SCALE 5 / 1	MATERIAL	<i>S. Yama</i>	<i>SH.K</i>	<i>T. Atsu</i>	
							THIRD ANGLE PROJECTION				
	△ ADDED : THIS SHEET	SEP.22.'98	S. Y	SH.K/S.NI	A. T		KYOCERA CORPORATION KYOTO JAPAN	DRAWING NO.		SHEET	
	CHANGED	DATE	DRAWN	CHECKED	APPROVED			KD-P86A76-C		7/8	

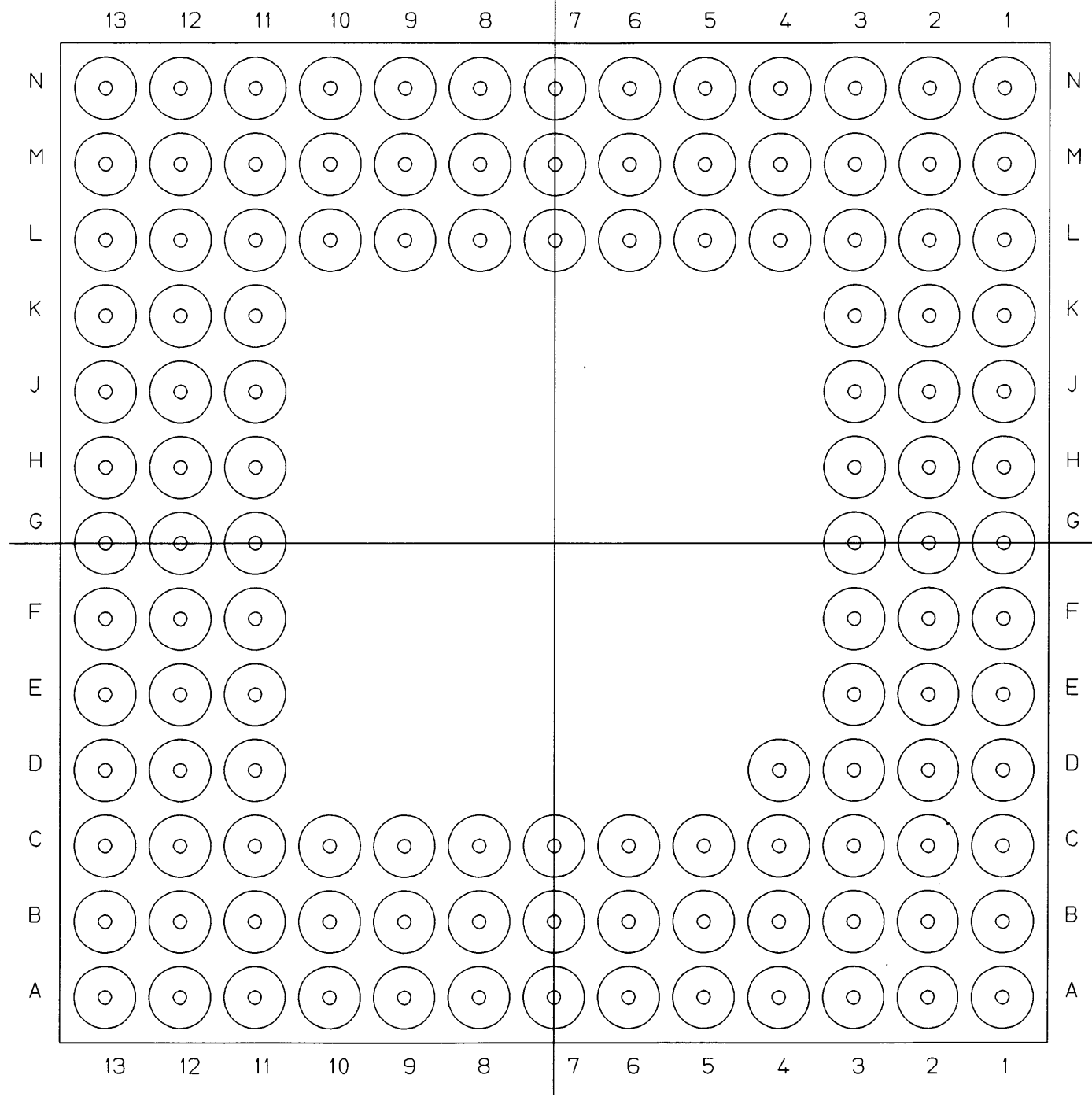

MP-5  
(TOP VIEW)

MODIFICATION						NAME 121 PIN GRID ARRAY PACKAGE	TOLERANCE UNLESS OTHERWISE SPECIFIED	DRAWN S. Y	CHECKED SH.K/S.NI	APPROVED A. T	DATE SEP.22.'98
						SCALE 5/1	MATERIAL				
							THIRD ANGLE PROJECTION	<i>S. Yama</i>	<i>SH.K</i>	<i>T. Atsu</i>	
	△	ADDED : THIS SHEET	SEP.22.'98	S. Y	SH.K/S.NI	A. T		KYOCERA CORPORATION KYOTO JAPAN	DRAWING NO.		SHEET
	CHANGED	DATE	DRAWN	CHECKED	APPROVED	KD-P86A76-C			8/8		